

Sundance® Spas 980 Kingston™

Specifications

Dimensions:	92" x 100" x 34" (233.7 cm x 254 cm x 86.4 cm)	
Perimeter	384" (975.4 cm)	
Seating Capacity:	6-7 Adults	
Dry Weight:	1,048 lbs (475 kg)	
Filled Weight (Spa Volume):	5,310 lbs (2,408 kg)	
Filled Weight (Average Fill):	4,392 lbs (1,992 kg)	
Water Capacity (Spa Volume):	511 US Gal (1,934 Liters)	
Water Capacity (Average Fill):	401 US Gal (1,518 Liters)	
Controls:	980 iTouch™ Glass Interface LCD Control, Displays Temperature, Time, Cycles and Jet/Air System Control. Offers Customizing of Filtration Cycles, Lighting, Water Temperature Setting and other features	
Water Delivery:	3 TheraMax High-Flow Pumps and 8-Hour Dynamic Flow Circulation System	
Pump 1:	North America (60 Hz): 1-Speed/2.5 HP Continuous, 11.3A Max., 56 Frame Export (50 Hz): 1-Speed/2.0 HP Continuous, 7A Max.	
Pump 2:	North America (60 Hz): 1-Speed/2.5 HP Continuous, 11.3A Max., 56 Frame Export (50 Hz): 1-Speed/2.0 HP Continuous, 7A Max.	
Pump 3:	North America (60 Hz): 1-Speed/2.5 HP Continuous, 11.3A Max., 56 Frame Export (50 Hz): 1-Speed/2.0 HP Continuous, 7A Max.	
Pump 4:	High-Output Dynamic Flow, 24-Hour programmable, factory default set to 8-Hour Filter/Circulation Pump (35 gpm) Programmable for Daily Start Time and Duration	
Total Hydrojets:	57	
Seat A Jets:	6 Fluidix Reflex	
Seat B Jets:	4 Fluidix Reflex	
Seat C Jets:	12 Fluidix-ST, 2 Fluidix Nex, 2 Pulsator, 2 Accu-Pressure	
Seat D Jets:	1 Vortex	
Seat E Jets:	2 Fluidix Nex, 4 Fluidix Reflex, 2 Fluidix Intelli-Jet, 2 Pulsator, 2 Accu-Pressure	
Seat F Jets:	2 Vortex	
Seat G Jets:	4 Vortex	
Footwell Jets (H):	8 Accu-Pressure, 1 Accu-Pressure (sidewall), 1 Vortex	
Air Blower:	High-efficiency, 1-Speed	
Aromatherapy Delivery:	12 Silent Air® Injector Jets with Quiet High Speed Air Pump	
Air Controls/Massage Selectors:	4/2	
Filter:	MicroClean® Ultra Filtration System, 130 ft² (2 interlocking cartridge filters)	
Water Treatment:	Automatic Brominator and Dynamic Flow Circulation System; Factory installed CLEARRAY Active Oxygen™ Clear Water System	
Lighting:	Multicolored LED Lighting System (1 Waterfall, 1 Footwell), Exterior Corner Lights, SunCooler Bin Lights, Seat Accent Lights	
Synthetic Cabinet:	Available in Coastal, Mahogany	
Shell Colors:	Platinum, Celestite (Gypsum), Monaco, Porcelain, Midnight	
Headrests:	4	
Heater:	Low Flow 5.5 kW With Titanium Element Export (50 Hz): Low Flow 2.7 kW with Titanium Element	
Electrical Requirements:	North America (60 Hz): 240 VAC@40A/50A or 60A; Export (50 Hz): 230-240 VAC@1x20A, 1x16A/1x20A, 3x16A (see manual for more configurations); or Suitable Rated Circuit Breaker To Comply With Local Electrical Regulations. Certain Countries May Require 2 Power Inputs; Two GFCI/RCD Breakers are Required For This Configuration.	
Limited Warranty*:	North America (60 Hz): 10 Years Shell, 7 Years Shell Surface, 5 Years Plumbing Component Leaks, 5 Years Equipment and Controls, 5 Years Cabinet, 5 Years Jets, 2 Years Lights, 1 Year Stereo Export (50 Hz): 10 Years Shell, 7 Years Shell Surface, 5 Years Plumbing Component Leaks, 5 Years Equipment and Controls, 5 Years Cabinet, 5 Years Jets, 2 Years Lights, 2 Years Stereo	
Waterfall Feature:	Adjustable Flow Rate; Colored Lighting	
Audio System (Optional):	Factory Installed BLUEWAVE® 2.0 Wireless Spa Stereo System with Auxiliary 3.5 mm headphone jack connection, Bluetooth® compatible, 4 premium speakers and a powered subwoofer	
Special Features:	Factory Installed SmartTub® module	

*(See Warranty Document for Specific Details)

Dimensions/Specifications Subject To Change Without Notice

Sundance Spas 980 Kingston

Operation/Seat Depths

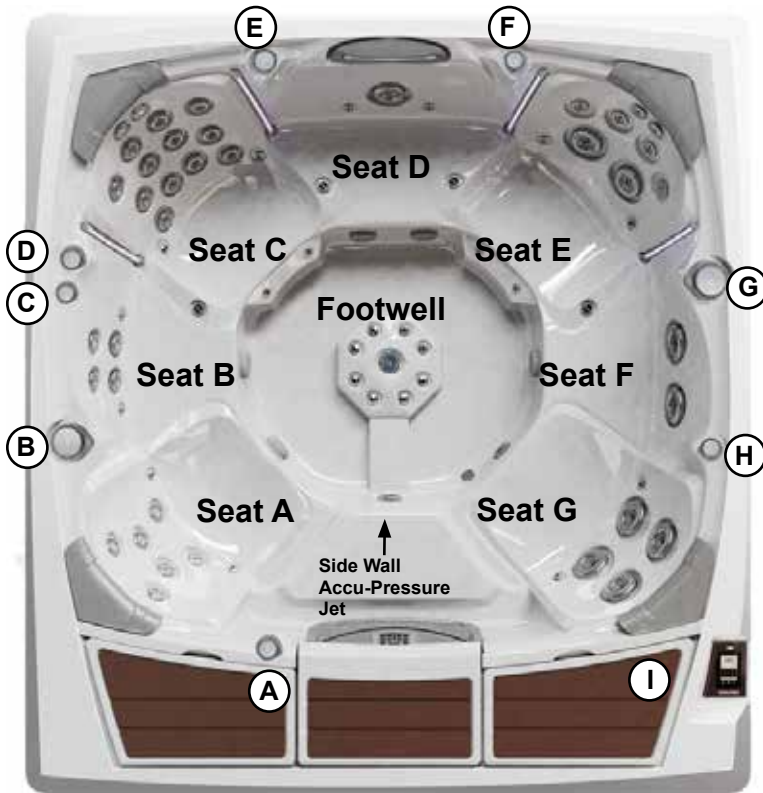

- (A)** Air Control - Activates Seat A Jets (6 Fluidix Reflex), Seat B Jets (4 Fluidix Reflex), Seat F Jets (2 Vortex), Seat D Jets (1 Vortex), and Footwell (2 Accu-Pressure, 1 Vortex) - Also used when draining the SunCooler Bins in the close position.
- (B)** Massage Selector [Pump 2] - Adjusts Massage Level Between Seat A Jets + 2 Footwell (2 Accu-Pressure) and Seat B Jets (2 Lower Fluidix Reflex) + Seat D Jets + Seat F Jets
- (C)** AccuSage Seat Valve - Adjusts Water Flow for Seat C (2 Fluidix Nex, 12 Fluidix-ST, 2 Accu-Pressure Jets, 2 Pulsators) + Footwell (2 Accu-Pressure)
- (D)** Air Control - Activates Seat C Jets (2 Fluidix Nex, 12 Fluidix Reflex, 2 Pulsators, 2 Accu-Pressure) and Footwell (2 Accu-Pressure)
- (E)** Waterfall Selector [8-Hour Circ. Pump] - Controls Waterfall Output
- (F)** Air Control - Activates Seat E Jets (2 Fluidix Nex, 4 Fluidix Reflex, 2 Fluidix Intelli-Jet, 2 Pulsators, 2 Accu-Pressure) and Footwell (2 Accu-Pressure)
- (G)** Massage Selector [Pump 1] - Adjusts Massage Level Between the Seat E Jets + Seat G Jets and Footwell (2 Accu-Pressure) + Footwell (2 Accu-Pressure)
- (H)** Air Control - Activates Seat G Jets (4 Vortex) and Footwell (2 Accu-Pressure)
- (I)** SunScents Dispenser

57 Total Jets

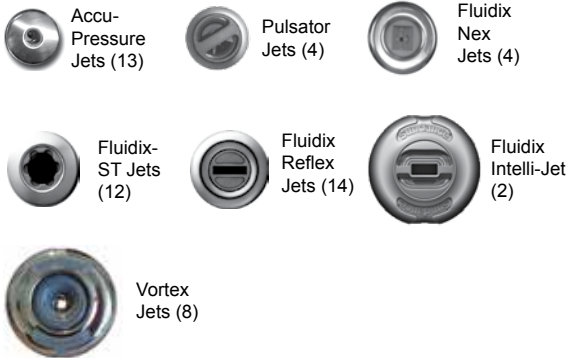

- Jets Pump 3: Seat C Jets + 2 Footwell Jets (2 Accu-Pressure)
- Jets Pump 2: Seat B (2 Upper Fluidix Reflex Jets) + Center Footwell Jet (1 Vortex) are always on when this pump is running.
- Jets Pump 1: Footwell Upper Right (2 Accu-Pressure Jets) + 1 Accu-Pressure Jet (Side Wall) in Footwell and SunCooler Perimeter Drains are always on when this pump is running.

Spa Operation Subject To Change Without Notice

SEAT DEPTHS

A = 23.25" (59.01 cm)	G = 22.00" (55.88 cm)
B = 21.00" (53.34 cm)	H = 17.00" (43.18 cm)
C = 26.00" (66.04 cm)	I = 29.25" (74.30 cm)
D = 20.50" (52.07 cm)	
E = 24.25" (61.60 cm)	SunCooler Bin Depth
F = 20.00" (50.80 cm)	J = 13.50" (34.29 cm)

Listed dimensions represent distance from top of acrylic to lowest point in seat. **Tolerance ± 0.5" (1.27 cm).**

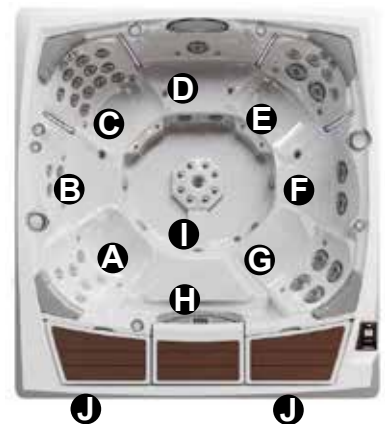

Dimensions/Specifications Subject To Change Without Notice

Sundance Spas 980 Kingston

Portable Dimensions

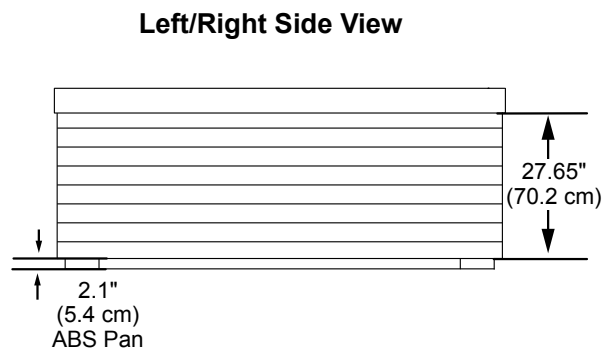
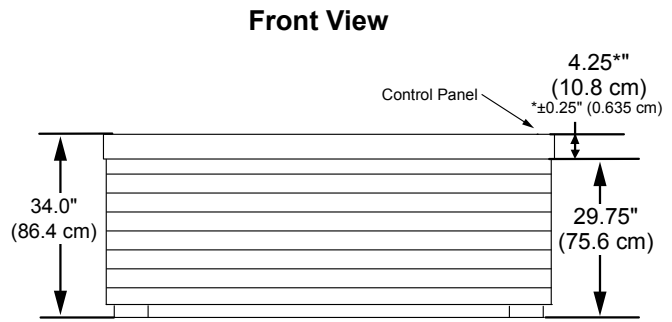
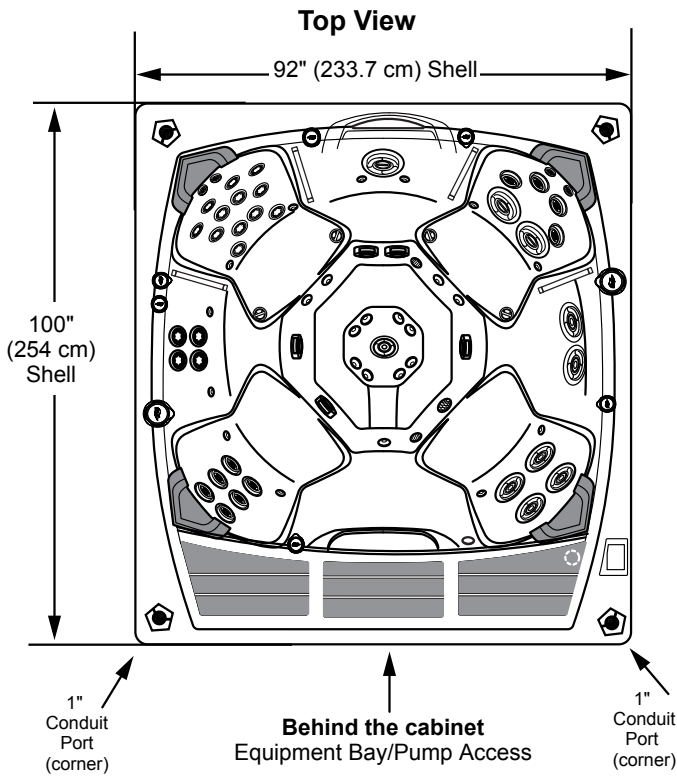

IMPORTANT! Always measure each hot tub for exact dimensions BEFORE designing its foundational support and/or decking.

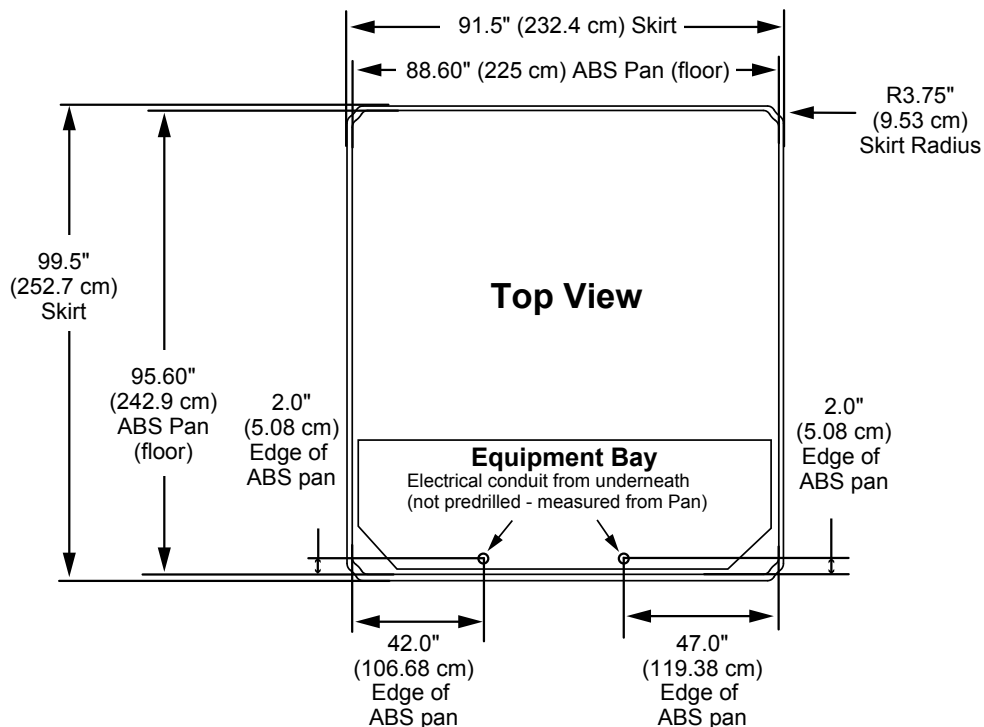

Dimensions/specifications subject to change without notice. Tolerance: $\pm 0.5"$ (1.27 cm)

Dimensions/Specifications Subject To Change Without Notice